

Dimensions

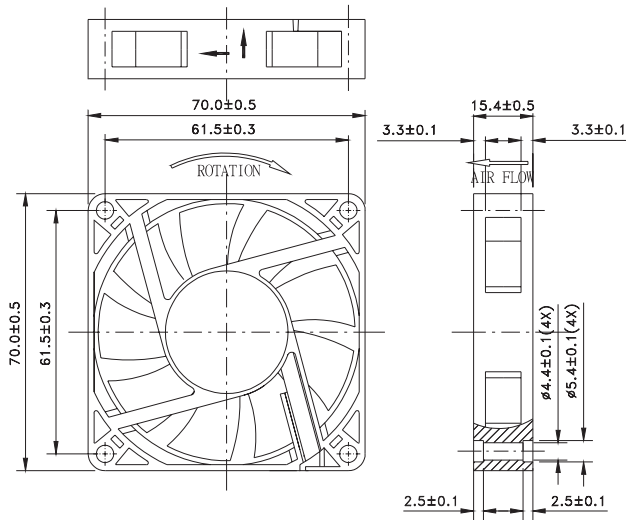

Air exhaust over struts. Rotational direction CCW looking at rotor.

Brushless DC Motor	Bearing Type
Weight: 55g Impedance protected Lead wire UL 1007 AWG 24	Ceramic

* All fans are with electronic protection against reverse polarity. The fan only operates when the polarity is correct.

Performance Curves

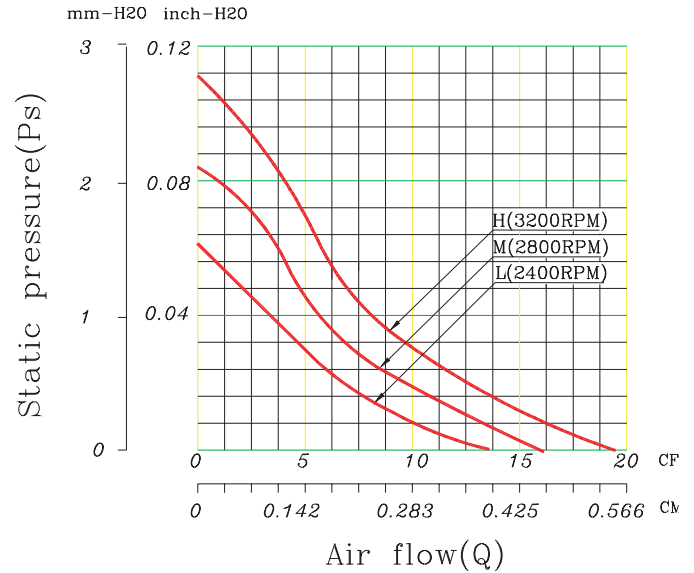

Function Options	
<input type="checkbox"/> Frequency Generator	<input type="checkbox"/> Auto Restart
<input type="checkbox"/> Temperature Control	<input type="checkbox"/> Rotation Detection

- * Please contact us for PWM function availability.
- * Please contact us for IP55 availability.
- * Safety Approval: CE, UL, TUV

Specifications

Model	Rated Voltage (VDC)	Rated Current (Amp)	Input Power (Watts)	Nominal Speed (RPM)	Airflow (CFM)	Static Pressure (inch -H2O)	Noise Level (dBA)
FAN7015C5H	5	0.28	1.40	3200	25.27	0.15	32.20
FAN7015C5M	5	0.23	1.15	2800	22.11	0.12	27.40
FAN7015C5L	5	0.18	0.90	2400	19.02	0.09	23.50

* Specifications are subject to change without prior notice.

* Check with your distributor for models available.