

Dimensions

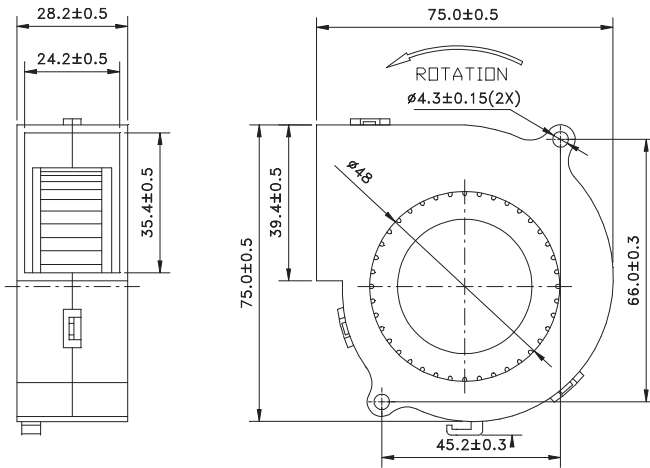

Performance Curves

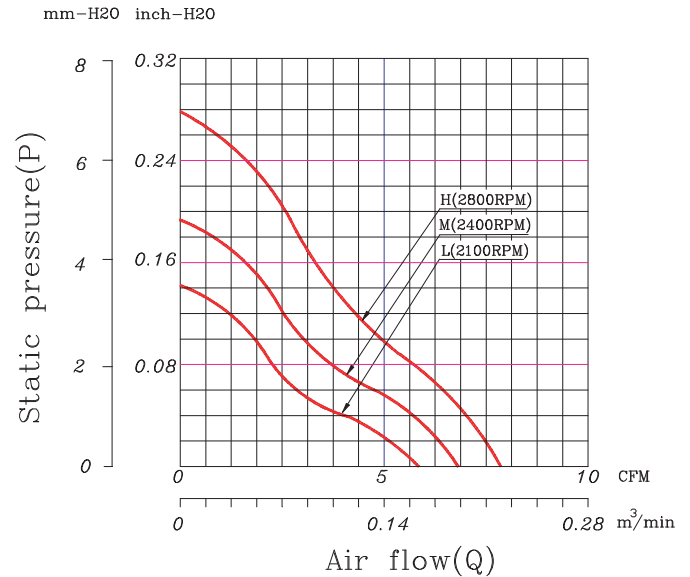

Air exhaust over struts. Rotational direction CCW looking at rotor.

Brushless DC Motor	Bearing Type
Weight: 80g Impedance protected Lead wire UL 1007 AWG 26	Ceramic

* All fans are with electronic protection against reverse polarity. The fan only operates when the polarity is correct.

Function Options	
<input type="checkbox"/> Frequency Generator	<input type="checkbox"/> Auto Restart
<input type="checkbox"/> Temperature Control	<input type="checkbox"/> Rotation Detection

- * Please contact us for PWM function availability.
- * Please contact us for IP55 availability.
- * Safety Approval: CE, UL, TUV

Specifications

Model	Rated Voltage (VDC)	Rated Current (Amp)	Input Power (Watts)	Nominal Speed (RPM)	Airflow (CFM)	Static Pressure (inch -H2O)	Noise Level (dBA)
FAN7528C12H	12	0.20	2.40	2800	7.86	0.27	36.00
FAN7528C12M	12	0.12	1.44	2400	6.76	0.19	31.00
FAN7528C12L	12	0.11	1.32	2100	5.98	0.14	26.50

* Specifications are subject to change without prior notice.

* Check with your distributor for models available.